



TABLE OF CONTENTS

Tabletop Labelling Machine	2
Label Applicator	2
Label Applicator	2
Top Label Applicator	8
Label Dispenser	14
Label Dispenser With Date Printer	14
Label Dispenser	17
Tabletop Labeller	20
Automatic Card Feeding Machine	20
Friction Feeder	22
Tabletop Bottle Labeling Machine (Standard Model)	23
Tabletop fully wrap around labeler	28
Tabletop Tamp Labeler	32
Top Tamp Labeler (Top Tamp Labeling Machine)	34
Tabletop Round Bottle Labeling Machine	36
Tabletop Automatic Top Labeler	40
Tabletop Top Labeler	44
Tabletop Two-Sided Labeler (with two label applicator)	50
Tabletop Wrap Around and Top Labeler	53
Semi-automatic Round Bottle Labeller	56
Tabletop Horizontal Round Bottle Labeler	63
Tabletop Vertical Round Bottle Wrap Around Labeling Machine	66



TABLETOP LABELLING MACHINE

LABEL APPLICATOR



LABEL APPLICATOR

SKU: LA1000

A label applicator plays an important role in a labeling machine, it is the heart of a labeler. It is one of the most widely used equipment in various industries. During the normal operation process, the labeling machine not only needs a strong mechanical structure but also a reliable label applicator.

After peeling off labels, automatically attaching labels to the product, container, or package. The labeling head is normally used in the manufacturing and packaging process. It can apply different label types and configurations to meet the needs of different industries.

Automated packaging line makes products more competitive

LA1000 Label Applicator can be equipped with packaging machines or other automation equipment easily. This application makes the label applicator an indispensable part of the production line. In addition, it is widely used in production lines of different industries, which include side labeling, top labeling, and round bottle labeling, etc.

Label Applicator LA1000 can be installed on production lines directly and easily connected to the PLC Control System. When the equipment is turned on, the label applicator can immediately synchronize with the production line, and its labeling speed can reach 8-12 meters per minute.

Automatically peel off the label, attach the label, and collect back paper to fix the flaws from manual operation, reduce human error

Compared with traditional manual labeling, the automated label applicator can easily peel off labels and accurately paste them to



products of various sizes and angles. Each label applicator is shipped with a back paper spool disc, and its function is to collect the back paper without stickers.

Operators don't need to waste time organizing the back paper. They only need to pull out the holder of the back paper to easily remove the entire roll of used back paper, saving valuable time and enhancing production efficiency.



LA1000, Label applicator makes labeling fast, precise, and diverse

The LA1000 sensor detects the labeling position accurately and dispenses labels by the stepper motor for stable and fast labeling. You can flexibly adjust the angle and position of it.

When the label applicator is connected to the PLC control system, the operator can set the labeling process through the controller, including the size, spacing, and position of the label, to take control of the labeling status. Meanwhile, improving the efficiency, accuracy, and functionality.

The versatility of LA1000 Label Applicator can be used in different industries to simplify the labeling process, enhance efficiency, and ensure the consistency and precision of the product.

The design of the LA1000 Label Applicator is suitable for a variety of label shapes, sizes, and materials, except for round labeling. It can be used for different types of product packaging. The combination of automation and versatility optimizes packaging operations, increases production capacity, and enhances market competitiveness.

Specifications



- **Labeling Motor:** Stepper Motor
- **Labeling Speed:** 8–10 m/min (according to product and label size)
- **Labeling Accuracy:** ±1 mm
- **Label Size:** Width: 10–100 mm, Length: 10–250 mm
- **Label Roll:** Inner Diameter: 75 mm, Outer Diameter: 300 mm
- **Power Supply:** 110 or 220 VAC, 50/60 Hz, single phase
- **Machine Size:** (L) 440 mm × (W) 243 mm × (H) 542 mm
- ❖ **Actual product specifications may vary**

Advantages:

- **Versatility:** Label Applicator is suitable for various products. Whether it is top labeling, bottom labeling, or side labeling, LA1000 can apply different labels, shapes, and materials to the product to packaging, providing flexibility.
- **Space-saving, can be widely used:** The machine is easy to install and space-saving. It's suitable for production lines in various industries such as food packaging, cosmetics, pharmaceuticals, chemicals, and electronics.
- **Automated production is more efficient:** Automated labeling and packaging operations significantly increase production speed.
- **Proactively remind the operator to change labels:** When the stickers have run out, the system will launch a signal alarm to remind the operator to replace the label roll.
- **Suitable for labeling production lines of multiple products:** Flexible multiple configurations to meet the needs of different industries.

Application

Suitable Goods:

Food & Beverages: Bottled Beverages, Food Can, Sauce, Yogurt, Food Boxes, Ice Cream, Panna Cotta, Chocolate, Food Storage Container, Olive Oil, Sandwiches, Egg Cartons, Aluminum foil bag.

Pharmaceutical and medical equipment: Various drug canisters, injections, medicine boxes, etc. The labels include the drug name, dosage, and expiration date.

Cosmetics and Personal Care Products: Lipsticks, Creams, Hair dyes, Hair oils, Serums, and Mouthwash. Labels make products easier to recognize.

Chemicals: Containers of chemicals, Lubricating oil, Car batteries, Car wash detergent, Engine oil.

Electronic products: Electronic Parts, SD cards, Plastic Boxes, Paper Boxes, Films, Metal Parts.

Logistics and Transportation: Shipping labels, Barcode, Tags, Promotion labels.



QUICK 3PL
LOGISTICS SIMPLIFIED



Suitable Product Shape:

Three-dimensional products, such as square boxes, flat bottles, round bottles, etc.

Flat products, such as cartons, zipper bags, and paper bags.

Suitable Product Material:

paper, glass, aluminum foil, plastic (PP, PE, PET, PVC), ceramic, metal (tinplate, aluminum, stainless steel).



QUICK 3PL
LOGISTICS SIMPLIFIED



Suitable Labels:

Self-adhesive labels, Promotion Labels, Anti-counterfeit Labels, Laser Labels, Barcode, fragile labels, ingredient labels, Polyester stickers, serial number labels, computer labels, product labels, waterproof stickers, Drug indication label(Off-label use)





Labeling Method:

Driving the label applicator with a stepper motor. When the paper roll reaches the peel plate, peel off the sticker and paste it onto the products. And the back paper will be rolled onto the back paper spool disc automatically.



Set the parameter of label sensor, detecting stickers precisely



Marking the rotation direction sticker on hand wheel, which is convenient for adjustment.

Suitable Industries:

Pharmaceutical industry, food industry, baking industry, cosmetics industry, biotechnology industry, manufacturing industry, daily chemical industry, technology industry, etc.

Machine Layout:

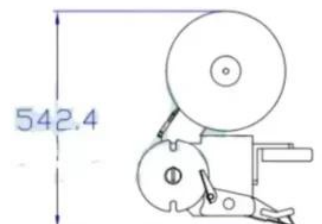
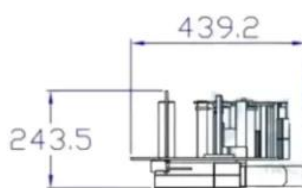

Categories: [Tabletop Labelling Machine](#), [Label Applicator](#)



QUICK 3PL

LOGISTICS SIMPLIFIED



QUICK 3PL

LOGISTICS SIMPLIFIED



TOP LABEL APPLICATOR

SKU: LA1100

A top label applicator is a labeling device that uses a stepper motor to achieve high-precision positioning through signal control.

Top Label Applicator accurately affixes labels to products or packaging, making it suitable for industries that require precise label application, such as the food, beverage, pharmaceutical, cosmetic, and other packaging industries. The key point of accurate label positioning is the label applicator with the stepper motor.

The stepper motor label applicator LA1100 can automatically peel off the label and accurately paste it to flat products of various sizes, providing a neat product labeling, enhancing the brand image, and achieving marketing results.

Whether for standalone labeling needs or integration into existing packaging lines, LA1100 Top Label Applicator can offer a fast and economical labeling solution. It saves production time, space, and costs, and improves labeling production efficiency.

Exquisite Top Label Applicator LA1100 - suitable for various labeling

The LA1100 is a larger-sized top label applicator. The biggest difference between LA1000 and LA1100 is the machine size. LA1100 is bigger to provide more stable and efficient labeling, as well as being suitable for more labeling requirements. Some components of the LA1100 are specifically arranged in different colors to make it more colorful. It also uses lighter materials for easier transportation and installation.

The labeling path of the LA1100 Top Label Applicator is short, making it convenient to replace label rolls and easier to adjust the labeling angles. With a simple and lightweight structure, it can be installed on a packaging machine without impacting the existing equipment.

Top Label Applicator is more suitable for high-accuracy labeling requirements of technology industry electronic products, food, pharmaceuticals, chemicals, precision electronic components, packaging bags, SSDs, RFIDs, etc.



QUICK 3PL
LOGISTICS SIMPLIFIED

The translucent design of paper spool disc makes operator easy to confirm the remaining label quantity quickly.



It allows to assemble printer bracket, making production faster.

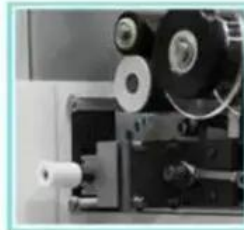

Efficient labeling solutions for a variety of packaging machines

The labeling speed of the LA1100 Top Label Applicator reaches 10 meters per minute. It is capable of standalone labeling operations and can also be integrated into a production line, providing flexibility for changeover.

By installing an extra swing buffer roller onto LA1100 can increase the label dispensing length, accelerate the labeling speed, allowing you to meet higher production needs and produce more products in less time. It is a fast and economical label applicator that is available to connect with you



QUICK 3PL
LOGISTICS SIMPLIFIED

User-friendly Design: Mark steps and direction of label threading clearly. It helps operator finish work smoothly.



Use back paper holder to hold the used back paper. Back paper spool disc automatically collects the back paper during. You can remove the entire roll of used back paper after the production.



Guide Ring: According to the label size, adjust the height of guide ring to avoid displacement of labels.



Advantages:

QUICK 3PL
LOGISTICS SIMPLIFIED

1. The label applicator is compact, easy to install, and space-saving. It's suitable for various places to use, saving cost and time.
2. With a short labeling path, quick and simple label roll replacement enhances production efficiency and accuracy.
3. The labeling angle can be adjusted flexibly, which is appropriate for various product shapes to meet diverse requirements.
4. It's driven by a stepper motor, ensuring precise and stable labeling and reducing labeling errors.
5. An intelligent microcomputer controls the machine, making other operations easy. It can be connected to other automated devices, enabling production integration and resource-saving in manpower.

Application & Advantage

Applications

Food & Beverage: Juice, canned food, condiments, boxed ice cream, bagged food, food storage containers, etc.

Pharmaceutical and supplements: Various bottles, infusion, medicine boxes, dietary supplements, etc., including product name, dosage, and expiration date.

Personal care and cleaning supplies: Conditioner, Shampoo, Body soap, Lotion, Sunscreen, Detergent, Laundry Detergent, Dishwashing, etc.



Industrial electronic products: Electronic Component, Color Box, Hardware Part, Terminal, SD Card, DDR, Battery, Engine Oil, Coolant

Logistics products: Carton, Shipping Mark, Barcode, Promotional Label



Suitable product shape

Three-dimensional products, such as square boxes, flat bottles, round bottles, etc.

Flat products, such as cartons, paper bags, packaging bags, and paper bags

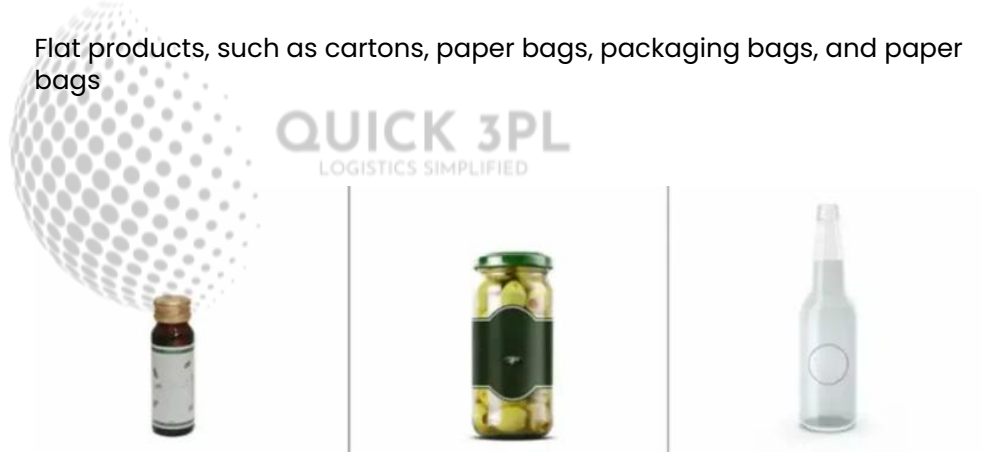

Suitable Materials

Paper, Glass, Aluminum Foil, Plastic (PVC, OPP, PP, PE, PET, HDPE, PLA), Metal (tinplate, aluminum cans, stainless steel), Styrofoam

Suitable Labels

Self-adhesive labels, Promotional labels, Anti-counterfeit Labels, Ingredient Labels, Laser Labels, Double-layer stickers, Bookmark Labels, Barcode Labels, PC Nameplate Stickers, Fragile Stickers, Heat-resistant Stickers, Polyester stickers, Serial Number, Product Labels, Heat-sensitive labels, Frozen Stickers, Void Label



QUICK 3PL
LOGISTICS SIMPLIFIED



Labeling style

Driving the label applicator with a stepper motor. When the paper roll reaches the peel plate, peel off the sticker and paste it onto the products. And the back paper will be rolled onto the back paper spool disc automatically.

Suitable industries

Food Manufacturing (processing) Industry, Baking Industry, Pharmaceutical Industry, Chemical Industry, Daily Chemical Industry, Technology Industry, Biotechnology Industry, Manufacturing Industry, Cosmetic Industry

Machine layout

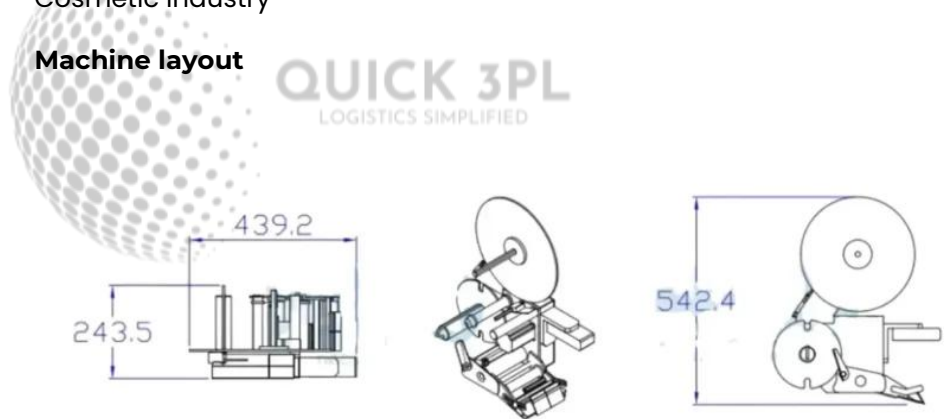

Categories: [Label Applicator](#), [Tabletop Labelling Machine](#)



QUICK 3PL

LOGISTICS SIMPLIFIED



QUICK 3PL

LOGISTICS SIMPLIFIED



LABEL DISPENSER



LABEL DISPENSER WITH DATE PRINTER

SKU: DS1020

Label dispenser with date printer has both label dispensing and date hot-stamping function, different from separate procedure in the past, the two steps (label dispensing and date/ batch coding) are all be done in the same machine frame /in the same time, and that could also shorten the time period of production and reduce manpower requirement.

The Label Dispenser With Date Printer can avoid common label wrinkles and attrition caused by manual handling; the active label dispensing process pulls the label roll out parallelly, which enables the operator be able to take the label easily and paste it on any place.

The automatic label dispenser with date printer device is equipped with an electronic control system that stabilizes the dispensing speed and dispensing length; furthermore, there is an active sensor that provides a precise and continuous label dispensing procedure.

The date coding machine can be applied to many kinds of paper, and the buyer can also select different types of carbon ribbon according to their requirement. The coder is driven by its motor, so there is no other force required; The dispensing and coding procedure are being done at the same time.

Label Dispenser With Date Printer can also provide a single function of either dispensing or coding to meet the actual production requirement, and the machine is capable to apply on various labels. For small labels, the machine can do dispensing in parallel, which can increase the production capacity and the scope of application.

How To Use A Label Dispenser With Date Printer For The Purpose Of Simultaneously Label Dispensing And Date Coding?

Just put the whole label roll in the winding plate, pull out the backing paper, wrap it on the roller beneath the winding plate, and fix the backing paper on the re-winding shaft. The used label roll will be collected automatically on the rewinding shaft, so the operator can remove the backing paper easily after production.



QUICK 3PL

LOGISTICS SIMPLIFIED

The operator fixes the label roll on the winding and rewinding plate, adjusting the machine, setting the dispensing length, manipulating the coding date/batch/weight, then turns the power on, and the machine is ready to work.

The Label Dispenser with Date Printer will print the numbers and letters you want on the label before dispensing it, and the coding position can also be adjusted.

The label can be pasted on any place you want; after detecting the label being taken away, the label dispenser with date printer will peel the next label and make the production uninterrupted.

Features

1. The date-coding label dispenser is small in volume and space-saving; it's simple for the operator to move it to any working place.
2. Label Dispenser With Date Printer, equipped with a temperature control system, the label dispenser is always stable.
3. With the rewinding function, which provides fluent and neat dispensing, the operator can replace the paper roll directly after production.
4. Label Dispenser With Date Printer can be applied to small-to-medium scale production; it provides variety in production.
5. With the production amount counting function, the operator can monitor the capacity easily.
6. The Precise detecting sensor provides an accurate label dispensing process.
7. Label Dispenser With Date Printer equipped with an electronic control system that can adjust coding speed, dispensing speed, and the coding position/ direction.
8. Simple paper roll winding and rewinding.
9. The coding area is movable because the printer is set on the machine.
10. Compact coding head. The coding front and line are changeable.
11. Coding ranges from 1 to 3 lines. It can be adjusted according to your requirements.
12. The Simple ribbon winding design makes it easy to change the spare parts.
13. Easy carbon ribbon wrapping design for quick ribbon changing.
14. A stable electronic system provides long-term, high stability of the production.

Specification

- Coding area: 1-3 lines, 1-14 alphabets for each line.
- Front height: 2-3mm (copper)
- Dispensing speed: 6 meters/ minute
- Label dimension: (L)20-100 mm (W)20-100 mm
- Carbon Ribbon: 100-122 meters



QUICK 3PL
LOGISTICS SIMPLIFIED

- Spare part: hot stamp carbon ribbon
- Power supply: 110/220 VAC, 50/60 Hz, 110W
- Dimension: (L)690 mm (W)340mm (H)445mm

Option Accessories

- Clear label sensor (for transparent label)

Categories: [Label Dispenser](#), [Tabletop Labelling Machine](#)



QUICK 3PL
LOGISTICS SIMPLIFIED



LABEL DISPENSER

SKU: DS1000



The label dispenser is electronically controlled. It's simple to operate and has no complicated setting procedure, which could save your time on operator training.

The compact label dispenser is equipped with a counting function, making it easy to monitor the production capability, and the machine can prevent old-fashioned, manual label dispensing problems such as label breakage, label wrinkling, and time consumption from happening.

The operator no longer needs to peel the label manually because the machine can dispense the label automatically and in parallel, keeping the label from being wrinkled, and the operator can just paste the label on any kind of product directly to make the production process more fluent.

The Label Dispenser can be applied to different kinds of labels in a wide range. The operators only need to pick & paste the label repeatedly, and they can easily be highly productive.

The automatic label dispenser has a small dimension, and it can be placed in any place. Also, the production capacity can be manipulated easily, and the backing paper will be collected automatically when all labels are used. There is an optional date coding device available, which could make the labeling/ date-coding procedure more efficient.

How To Increase The Manual-Labeling Efficiency By Using The Label Dispenser Machine?

First, put the new label roll on the spool disc of the electric label dispenser, and adjust the device according to the label width. After that, pull the backing paper out and wrap it around the rolling shaft, then fix the backing paper on the rewinding shaft.

After doing these things, the backing paper will be collected automatically. Adjust the dispenser and turn on the power, and your production will have higher efficiency.

The label will be peeled parallelly and one-by-one, dispensing, making the production procedure continuous, and the label can be pasted on the product directly. Furthermore, the production speed is adjustable, depending on the requirement.

- **Label length:** (L) 8-300mm (W) 6-100mm
- **Power supply:** 110/220VAC, 50/60 Hz
- **Label Roll Inner Diameter:** no less than 25 mm



QUICK 3PL
LOGISTICS SIMPLIFIED

- **Label Roll Outer Dia.:** no larger than 250 mm
- **Dispensing speed:** 6-7 meters per minute
- **Dimension:** (L) 330mm (W) 210mm (H) 180mm
- **Machine Weight:** 3.5 kg

Features

1. The label dispenser machine is equipped with an automatic label counting function, making it easy to monitor the capacity and avoid miscounting that might happen.
2. Label Dispenser is also equipped with a label brush device, so the label will have no wrinkles when dispensing.
3. The device is simple to operate, and the dispensing length can be adjusted simply by a time controller.
4. The Accurate controlling system provides label dispensing adjustment.
5. The electric label dispenser has a small volume size and light weight, which can be placed anywhere.
6. Label Dispenser can keep working for a long period of time, and you don't need to worry about overheating.
7. The device is driven by an advanced AC motor that has high endurance.
8. Automatic label detection, and the label will be waiting to be picked up.
9. No more manual peeling. Saving your time.
10. Label Dispenser can be applied to different sizes of labels. High cost-performance ratio.
11. An accurate fiber amplifier ensures the label dispensing length.
12. Automatic backing paper collecting. The backing paper won't fall off.

Option Accessories

- Transparent label sensor
- Date coder/printer

Categories: [Label Dispenser](#), [Tabletop Labelling Machine](#)



QUICK 3PL

LOGISTICS SIMPLIFIED



QUICK 3PL

LOGISTICS SIMPLIFIED



TABLETOP LABELLER

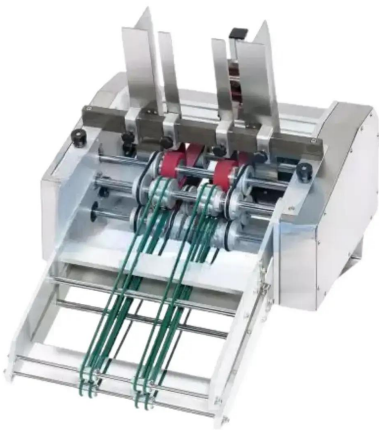

AUTOMATIC CARD FEEDING MACHINE

SKU: CF1100

The automatic card feeding machine is designed to feed cards, bags, or sheets continuously, which takes a stack of cards or sheets and separates them into a single, pitched stream onto a conveyor. An ideal feeder for any industry that needs to put the instructions, tag, envelope, card, bag, and so on. Compact design for being moved and connected with a production line easily. The most economical model for a flat paper card and plastic bag automatic feeder.

Features

1. AC motor driven, speed adjustable.
2. Feeding counter, record the material quantity indeed.
3. Height knob equipped, adjust easily.
4. Adjustable bracket, suitable for various materials
5. Mounted on a guide rail, helps material to be fed smoothly
6. Efficient production for up to 100mm loading volume, which saves time to supply the material.
7. Compact design, saving space, and conveniently moved.
8. Can be connected to other machines.
9. Made out of stainless steel and anodized aluminum, easy to clean and maintain.
10. Independent machine driving system.
11. Heavy-duty frame structure.

Specification

- **Feeding Speed:** 0- 6 Meters/min
- **Material Size:**(Min):(W)50(L)100(H)0.1mm;
(Max):(W)200(L)400(H)2mm
- **Power Supply:**110/220 VAC, 50/60 HZ, 1 PHASE
- **Dimension:** (L)730mm × (W)484mm × (H)547mm

Categories: [Tabletop Labelling Machine](#), [Tabletop Labeller](#)



QUICK 3PL

LOGISTICS SIMPLIFIED



QUICK 3PL

LOGISTICS SIMPLIFIED



FRICITION FEEDER

SKU: CF1000

The Friction feeder CF1000 is designed to feed sheets or cards continuously to an existing vacuum base or conveyor base. This is a very simple Friction feeder machine that takes a stack of cards or sheets and separates them into a single, pitched stream onto a conveyor. Suitable for feeding general flat products from various industries such as boxes, paper cards, cardboards, carton sleeves, Z-fold leaflets, and booklets etc. The feeder is designed with a compact design for being moved and connected with a production line easily.

Features

1. Automatic feeding device
2. Conveying speed is adjustable
3. Can be adjusted according to product sizes
4. Can be connected with a labeling machine or used for other purposes
5. With high mobility to make it easy to change the production places
6. The most economical model for flat paper card feeding
7. Easy to clean for maintenance and longevity
8. Strict quality control with the best after-sales service
9. Made of SUS#304 stainless steel and aluminum alloy for frame construction to comply with cGMP standard

Specifications

- **Driven by an AC Motor**
- **Power supply:** 110 or 220VAC; 50/60Hz; single phase
- **Dimensions:** (L) 650mm, (W) 350mm, (H) 450mm

Option Accessories

- Requirements for connecting with labelers

Categories: [Tabletop Labelling Machine](#), [Tabletop Labeller](#)



TABLETOP BOTTLE LABELING MACHINE (STANDARD MODEL)

SKU: LR110A



Tabletop Bottle Labeling Machine can do all kinds of round bottle labeling jobs done with compact in size, easy in mobility. Various labels like self-adhesive labels, multilayered labels, fragile labels, coated paper stickers, waterproof beer labels, anti-counterfeiting labels, or Kraft paper stickers can be easily applied by LR110A. The final product is fine, beautiful, and tasteful.



Tabletop Bottle Labeling Machine is designed for multiple types of round bottles with either full wrap-around or 1/2 labels, regardless of the material of the bottle. There is no need to set up change labeling parameters and adjust the speed repeatedly during production.

One person can operate the machine. Even if it only takes one person to operate the labeler, human errors can still be greatly reduced. The labeling speed can easily reach around 20 to 50 bottles per minute, making it your first choice to meet all the round bottle labeling needs.

Easy to operate, reduces human error

Our semi-automatic bottle labeling machine LR110A is an intelligent labeling machine, which is equipped with an electronic control panel for easy operation. There is no need to change the setup frequently during production, which can greatly reduce human errors and labor costs, and increase production speed and efficiency.

Provide customers with a high-quality round bottle labeler and multiply production capacity

The Tabletop Bottle Labeling Machine can also be combined with other packing machines, such as cappers, fillers, and date coders, as a high-performance production system. It also comes with a labeling smoothing wrap belt module and a durable conveyor belt. The labeling result is exquisite, firm, and not easy to detach.

Effectively multiplies the production capacity for customers, thereby improving their international competitiveness.



QUICK 3PL
LOGISTICS SIMPLIFIED

Resistant Belt

Wear resistant belt with long service life. It makes sure products are delivered stably. The LR110A could shipped with bottle gating system.



Wrap Unit

Exquisite labeling without wrinkles.



Quick3PL has been dedicated to professional research and development for many years. Furthermore, we pursue creating high-quality and durable bottle labeler machines at all costs, providing customers with outstanding products and solutions.

The Tabletop Bottle Labeling Machine LR110A is suitable for the manufacturing environment of various industries. Our product is your best choice! We provide specific installation instructions.

Application & Advantage

Suitable goods

Nutritional supplement, throat lozenge, pickled cucumber, wheat gluten with peanut, diffuser, round tube, pepper mill, oil dispenser, cleansing oil, sweet chili sauce, conditioner, large round bucket, ampoule, poster paint, alcohol spray, mosquito repellent, etc.



Suitable container shape

Upright round bottle, cylindrical, hexagonal, small bottle, beer bottle,



plastic bottle, glass bottle or octagonal bottle, and products that need a label with a single sticker and 1/2 or full circle label.



Suitable container material

Glass, paper products, cans, tinplate, Styrofoam, tea caddy, metal, and various plastic bottles are suitable.



Suitable labels

Kraft paper sticker, self-adhesive label, multilayer label, barcode sticker, laser security label, appliance label, fragile label, transparent label, coated paper sticker, pearly label, wine label, nameplate sticker, security label.

Labeling style

The label sensor detects the bottle. While labeling, rotate the bottle by 1, 3/4, 2/3, or 1/2 circle.

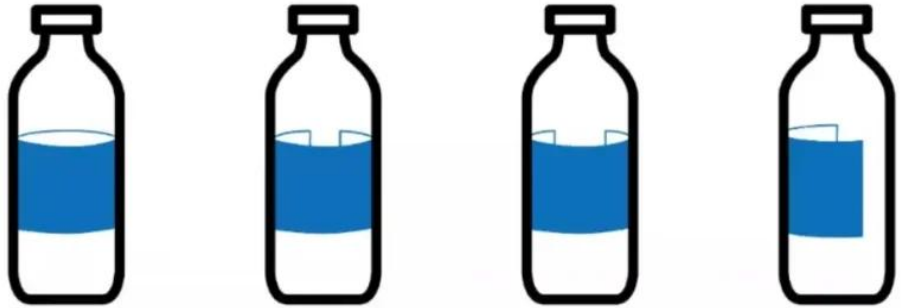

Suitable industries

Pharmaceutical industry, cosmetic industry, food industry, biotechnology industry, manufacturing industry, daily necessities chemical industry, high-precision product technology industry, etc.

Features

1. Widely used in various industries: Bottles from everyday life are applicable, such as Vitamin B, poster paint, hand soap, wine, and olive oil.
2. The bottle labeling machine could ship with a bottle gating system to match the labeling speed
3. Components of the labeler parts are customizable and have great precision
4. The tabletop round bottle labeler is convenient and highly mobile. It's small-sized and space-saving.
5. Food-grade conveyor belt is wear-resistant with a long service life. It delivers bottles steadily and quickly.
6. Engineering plastics, there are more than 80% recyclable material: The machine is made of engineering plastics, is impact resistant and high-temperature resistant, in addition to good thermal and mechanical performance. Most material is recyclable, in turn achieving sustainable development.
7. Tabletop Bottle Labeling Machine is made of SUS#304 stainless steel and aluminum alloy, and has passed the GMP certification standard
8. The Tabletop Bottle Labeling Machine LR110A can be combined with our filler or capper as a production line: The automatic warning function will be switched on in case of missing or damaged labels.

Specifications

- **Labeling Speed:** 20–50 btl/s/min (depending on the size of the bottle and label)



QUICK 3PL
LOGISTICS SIMPLIFIED

- **Bottle Size:** Diameter 16 mm–100 mm, Height 30–160 mm
- **Label Size:** Width 10–100 mm, Length 10–300 mm
- **Label Reel:** Inner Diameter 75 mm, Outer Diameter 300 mm
- **Power Supply:** 110 or 220 VAC, 50/60 Hz
- **Machine Size:** (L) 950 mm × (W) 890 mm × (H) 450 mm

Option Accessories

- Bottle infeed turntable
- Bottle gating system
- Date coder
- Transparent label sensor
- Particular roll labeling set: suitable for 3/4 to 1 circle labeling

Categories: [Tabletop Labelling Machine](#), [Tabletop Labeller](#)



QUICK 3PL
LOGISTICS SIMPLIFIED



TABLETOP FULLY WRAP AROUND LABELER

SKU: LR117A



The Tabletop fully wrap around labeler LR117A can position the bottles in the exact place and apply labels efficiently. Labeling speed ranges from 20 to 50 bottles per minute, and it's suitable for various types of round bottles. The machine sets parameters through the microcomputer control interface.

Tabletop fully wrap around labeler can be operated by a single person without complicated procedures. Containers like easy-open cans, aluminum cans, and glass/ plastic bottles are suitable for this machine.



Common products in our daily life are appropriate, such as medications, lutein, spray bottles, cosmetics, sparkling water, beer, fruit jam, instant coffee, and milk powder can be labeled by LR117A. We provide steady and perfect labeling results, which are exquisite and perfect with no wrinkles or air bubbles on labels

Save time, space, and cost, thereby increasing efficiency and productivity

The LR117A Tabletop fully wrap around labeler is small-sized with a straightforward touch-tone design. It's correct, accurate data reduces the number of tedious production steps for customers. You can start label production quickly with just one person, as easily as switching the machine on. It's suitable for small and medium-sized production with limited labor. Cutting the labor cost and increasing productivity at the same time.

Fixpoint, fast, accurate, and high-quality labeling

The Tabletop Round Bottle Labeler is equipped with sensors. It can put bottles in the middle of the conveyor, meanwhile while rotating the bottle and labeling. After labeling, bottles will be conveyed to the outfeed end. This machine is equipped with a smooth label mechanism. Its product is delicate and tasteful, and it's also an exquisite machine that provides you with excellent labeling results.



Label Sensor

Label sensor can automatically detect labels without any error.



Metalwork

Our metalwork are special treated to refined the details and exquisite. Thus our product is your best choice!

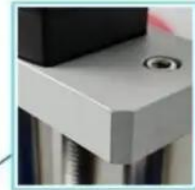

Application & Advantage

Suitable goods

Gastrointestinal drug, lutein, barbecue sauce, shampoo, cosmetics, sparkling water, beer, fruit jam, diffuser, peanut butter, bottled water, spray bottles, instant coffee, milk powder, tea caddy, can, tub of ice cream, tomato paste, pasta sauce.



Suitable container shape

Cylindrical products with 1/2 to full circle wrap labels.

Suitable container texture

Styrofoam, tinfoil, glass, paper can, easy open can, metal, and various plastic bottles.



Suitable labels

Standing sticker, logo label, barcode sticker, fragile label, hot stamping stickers, laser security label, multilayer label, self-adhesive label, polyester sticker, and transparent label.

Labeling style

Put bottles in the middle of the conveyor, meanwhile rotating the bottles by 360° or 180° and labeling them. After labeling is done, bottles will be taken to the end of the conveyor.



Suitable industry

Pharmaceutical industry, food industry, cosmetic industry, biotechnology industry, manufacturing industry, chemical industry, high-precision product technology industry, etc.

Features

1. Environmentally friendly material: The Tabletop fully wrap around labeler is made of engineering plastics that are impact-resistant and high-temperature resistant, in addition to well thermal and mechanical performance. There are more than 80% recyclable



materials from the machine, and we hope to make our contribution to the global environment.

2. Japanese-made stepper motor for high accuracy: The Tabletop fully wrap around labeler is equipped with a Japanese stepper motor and photoelectric sensor, which precisely detects and arranges bottles in place. Setting error won't exist.
3. Small logo stickers or full wrap-around labeling are suitable: Label size depends on the size of the bottle. Except for transparent label, LR117A is suitable for various labels and stickers, including self-adhesive labels, barcode labels, standing stickers etc.
4. Tabletop fully wrap around labeler is widely used in different kinds of industries
5. High quality and productivity of labeling: The final product is pretty, delicate, and solid without wrinkles.
6. The Tabletop fully wrap around labeler can combine with other fillers or cappers as a production line
7. Tabletop fully wrap around labeler is made of SUS#304 stainless steel and aluminum alloy. The machine is firm and durable; besides, it's easy to clean and maintain.

Specification

- **Labeling Speed:** 20-50 pcs/min (depending on the sizes of the bottle and label)
- **Bottle size:** Diameter 16mm-100mm; Height 30-160mm
- **Label Size:** Width 10-100mm; Length 10-300mm
- **Label Roll:** Inner Diameter 75mm; Outer Diameter 300mm
- **Power Supply:** 110/220VAC; 50/60Hz
- **Machine Size:** (L) 850mm (W) 830mm (H) 410mm

※ Actual product specifications may vary

Option Accessories

- Bottle infeed turntable
- Bottle gating system
- Date coder
- Transparent label sensor

Categories: [Tabletop Labeller](#), [Tabletop Labelling Machine](#)



TABLETOP TAMP LABELER

SKU: LS1000

The LS1000 Tabletop tamp labeler is powered by step motors, which produce stable labeling outputs. Equipped with a labeling head and conveyor, LS1000 can fulfill the labeling task with high accuracy. The tabletop tamp labeling machine uses a pneumatic applicator to retrieve label stickers from their holders.

Tabletop Tamp Labeler can easily apply labels onto different shapes of bottles, even those with unusual or concave surfaces, or those with unusual angles, and those made of soft materials. It applies labels to bottles of a wide range of products, including those of electronics, food, the chemical industry, biotechnology, and pharmacies.

High Quality Tabletop Tamp Labeler

Tabletop tamp labeler LS1000 is of a size. Such a space-efficient feature makes it the best solution for enterprises that have only a limited workspace. Its labeling speed is 20-40 pieces/min, depending on the material of your specific product. It retrieves label stickers through a pneumatic extendable retriever, which connects to its labeling head.

Together, they allow the tabletop tamp labeling machine NLS-100 to fulfill labeling tasks with great precision. Tabletop Tamp Labeler LS1000 is easy to operate and set up, which is great for a single-person operation production line. Different accessories can be added to the tabletop tamp labeler to apply label stickers of different sizes. LS1000 is the best solution to all self-adhesive labeling needs.

Features

1. Mobile comes in a small size. Easy to operate in various workplaces.
2. The Tabletop Tamp Labeler's pneumatic-operated labeling head makes it fast and easy to apply labels onto unusual surfaces and different targeted positions.
3. Tabletop Tamp Labeler's Japanese-made photoelectronic eye helps to meet the demands of high precision.
4. Optional printers allow the tabletop tamp labeler to print and label in one single process.
5. Tabletop Tamp Labeler is capable of applying labels to unusual positions with great precision.
6. Standardized labeling module. Easy to maintain.
7. Labeling delay adjustment meets different labeling needs.
8. Adjustable labeling position, conveyor height, and angle. Applicable to a wide range of products.
9. Humanized design makes the operation easy, even for first-timers;



- it helps to minimize training.
10. User-friendly hand-wheel adjustment unit makes it easy to apply labels onto products with different heights.
 11. Photoelectronic sensors automatically identify the targeted positions, eliminating labeling errors.
 12. Optional wider conveyor belts meet various labeling needs; applicable to a wide range of products; optimize productivity.
 13. Tabletop Tamp Labeler is made of SUS#304 stainless steel and high-quality anodized aluminum, provides great durability and easy cleanup.

Specification

- **Labeling Speed:** 20-40 pcs/min (Speed varies depending on products and label sizes)
- **Label Type:** All opaque labels
- **Label Length/Width:** 10-300 mm/ 10-100 mm
- **Label Roll Diameter:** Inside 75 mm; Outside 300 mm
- **Power Input:** 110/220 VAC; 50/60 Hz
- **Dimensions:** (L) 610 mm, (W) 730 mm, (H) 1000 mm

Option Accessories

- Date coder
- Imported high-end servo motor
- Motor-powered star wheel
- Solid stainless steel stand or box base.
- Transparent label sensor (for transparent labels)

Categories: [Tabletop Labelling Machine](#), [Tabletop Labeller](#)



TOP TAMP LABELER (TOP TAMP LABELING MACHINE)

SKU: LS1200

The top tamp labeler LS1200 is space-efficient. Each part of it meets a high standard. Its high-quality photo-electronic sensors help to improve labeling precision greatly.

The top tamp labeler LS1200 works especially great for products of high labeling precision needs, such as electronic accessories, micro-chips, cell-phone batteries, eyelash glue, and pharmaceutical syrup bottles. Thus, the top tamp labeling Machine provides the best labeler solutions to industries like pharmacies, cosmetics, personal care, and consumer electronics.

High-Quality Top Tamp Labeler

The top tamp labeler is controlled by microcomputers. It operates automatically and thus helps to optimize labeling speed and productivity efficiency.

Customized reserved holes are available for future production needs or for optional accessories like barcode imprinters, which serve as add-ons to upgrade the top tamp labeler to an automatic production line, which fulfills the tasks of printing and labeling in one single process.

Such a line helps to considerably reduce the need for quality control management and training, and thus effectively brings down labor costs.

Features

1. Top Tamp Labeler is easy to operate without complicated manual setups.
2. Top Tamp Labeler is easy to switch labeling products, even by a single operating person.
3. Programmed with two operation modes: automatic and manual, bringing flexibility to your production.
4. Integrated control buttons in one control box, providing an effortless control experience.
5. Visualized productivity is shown on the screen of the control panel; execute planned production with ease.
6. Photo-electronic eye actively detects labeling products with precision, eliminating labeling errors
7. Top Tamp Labeler is equipped with a tamp pneumatic applicator, fulfilling labeling tasks with stability and precision, labeling on the same targeted positions repeatedly.
8. Adjustable applicator heads allow a wide range of applications.
9. Optional barcode imprinter; carrying out printing/labeling dual



- task in one single process.
10. Made of high-quality stainless steel with an aluminum stand; Light in weight and easy to maintain.
 11. Powered by a stepper motor, it dispenses labels with stability.

Specification

- **Labeling Speed:** Max. 6 meters/min
- **Labeling Precision:** +/- 0.1 mm
- **Applicable Labels:** Max. (W) 10 mm * (L) 10 mm; Min. (W) 100 mm * (L) 300 mm.
- **Label Roll Diameter:** Inside 75 mm; Outside 300 mm
- **Power Input:** 110/220 VAC; 50/60 Hz, Single phase.
- **Air Requirement:** 2.5 kg/cm²
- **Dimensions:** (L) 515 mm * (W) 443 mm * (H) 577 mm.

Option Accessories

- Barcode Imprinter

Categories: [Tabletop Labelling Machine](#), [Tabletop Labeller](#)





TABLETOP ROUND BOTTLE LABELING MACHINE

SKU: LR1000



The tabletop round bottle labeling machine LR1000 is very suitable for small and medium manufacturers who want to improve the quality of packaging. The round bottle labeler is controlled by a micro-computer; this labeling machine can complete high-precision labeling that is difficult to complete by manual work.

The labeling is consistent, horizontal, and very beautiful. The LR1000 series round bottle labeler is recommended to clients with limited production space. The length of the machine is about the length of an adult's arm, so it can be used in a small space for semi-automatic production.

Tabletop Round Bottle Labeling Machine's space-efficient size makes it the best bottling solution for small or medium-sized businesses expecting moderate but versatile labeling needs. The tabletop round bottle labeling machine can be combined with an inkjet printer / Date coder to satisfy your further production needs.

Tabletop Round Bottle Labeller Advantage

1. The microcomputer control panel adjusts parameters, easy to use.
2. Label replacement is simple and fast.
3. Driven by a stepper motor, quiet and smooth.
4. Suitable for small space operations.
5. Comply with cGMP.
6. It applies to an extensive range of products in different industries.

Application & Advantage

Speed Adjustment-Free Smart Round Bottle Labeller

This round bottle labeling machine is an economical model and is recommended for small and medium producers who have a small amount and diversification and pursue high-quality. Simple operation and high supportability. Equipped with a smart photo-electronic eye, it automatically applies labels to round bottles with only two buttons pushed.

Such an automatic feature frees you from complicated parameter settings and speed adjustments, thus avoiding setting errors. The conveyor speed and labeling head position can be flexibly adjusted according to your production needs and the bottle size.

Tabletop Round Bottle Labeling Machine applies to a wide range of



industries: The food, medicine, biotechnology, and chemical industries can use this labeler to achieve stable labeling quality. This round bottle labeler equipment is worthy of your investment.

Tabletop Round Bottle Labeling Machine is suitable for

Cylindrical products such as edible oil, sauces, wine bottles, medicine bottles, tea cans, lotions, shampoos, detergents, perfumes, lipsticks, lip gloss, plastic bottles, glass bottles, aluminum cans, iron cans, etc.

Label

Self-adhesive labels, anti-counterfeit labels, promotional labels, tamper-evident labels, tube labels, vial labels, lab labels, transparent labels (work with photoelectric sensor for transparent labels).

Labeling style

wrap-around labels, half-wrap bottle label, single-side labels.

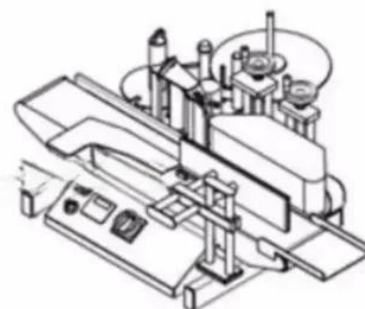
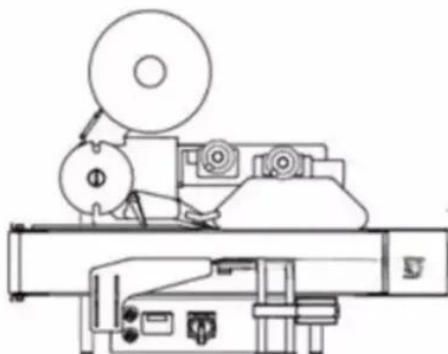



Features

1. Adjustable labeling height and angle through the PLC program; no manual adjustment needed.
2. A user-friendly control system makes the operation easy and fast.
3. Equipped with a finely made Japanese photo-electronic eye, it detects targeted labeling position with great accuracy.
4. Powered by step motors, producing stable and efficient labeling outputs.
5. Modularized machine parts: Satisfying your different labeling needs with different modules.
6. Setting Label length through the PLC system, changing products with ease.
7. Streamlined conveyor belt moves an extensive range of products; Switching labeling products with ease and efficiency. Space-efficient size: great for limited workspace.
8. Equipped with a label-pressing sponge, firmly apply labels to your applications.
9. Micro-computer-controlled PLC system meets production goals with efficiency.
10. Synchronized labeling speed and conveyor speed, making speed adjustment fast and easy.
11. The labeling roll firmly attaches labels to your products.
12. Equipped with automatically-detecting photoelectric eyes, the round bottle labeling machine NLR-100 makes it easy to change labels and label products at the same time. No further adjustment is needed.
13. Made of stainless steel and hardened aluminum alloy, providing great solidity and durability.
14. Easy for maintenance and clean up.
15. Comes with rigorous quality checks and comprehensive customer support.
16. Labeling speed varies depending on the size of your labels and that of your products.
17. Customizable machine parts; extendable range of applicable products.
18. Equipped with adjustable conveyor fences and a hand-wheel system, providing an excellent control experience.

Specification

- **Powered by stepper motors**
- **Labeling Speed:** 20-60 pcs/min (depending on your specific applications and label sizes)
- **Labeling accuracy:** ± 1 mm (depends on product and label size)
- **Bottle size:** diameter 16 mm - 90 mm/ height 30 -160 mm
- **Applicable Label Width/Length:** 10-100mm/ 20-300mm
- **Labeling Roll Diameter:** Inside 75mm; Outside 300mm
- **Power Input:** 110/220 VAC; 50/60 Hz
- **Dimensions:** (L) 1234mm (W) 839mm (H) 540mm



QUICK 3PL
LOGISTICS SIMPLIFIED

Option Accessories

- Tamp fixed point roll-labeling sets: applicable for the labeling of 3/4 to whole wraparound bottle body; with great precision.
- photoelectric sensor for transparent labels.
- Date coding machine/ Ink jet printer
- Automatic feeding machine

Categories: [Tabletop Labeller](#), [Tabletop Labelling Machine](#)



QUICK 3PL
LOGISTICS SIMPLIFIED



TABLETOP AUTOMATIC TOP LABELER

SKU: LT1000



The Tabletop automatic top labeler LT1000 is an economical, budget-friendly piece of machinery that is compact and sturdy. It not only performs with delicate precision but also does so for all the products that it is called upon to label.

Tabletop Automatic Top Labeler is very user-friendly, as the control panel and visible height parameters make it easy to switch between labels and products without having to use tools or switch out parts.

By reducing the time needed to switch, the machine helps avoid the loss of valuable production time, and with its small size, it helps save work space as well.

Desktop Labeler Advantage

1. Label various flat products with one labeling machine.
2. The microcomputer control panel adjusts parameters, easy to use.
3. Label replacement is simple and fast.
4. Driven by a stepper motor, quiet and smooth.
5. Suitable for operation in small spaces.
6. Complies with cGMP.

Application & Advantage

Tabletop top labeler with an extensive range of applications

It is difficult to achieve fast, completely accurate labeling with manual labor. The tabletop top labeler machine is perfect as a first move to automated production for growing businesses. It can handle industrial production, yet its small size and simple interface make it more approachable for first-time users.

Tabletop Automatic Top Labeler will free up personnel from labeling products, allowing their energy to be redirected to more meaningful procedures. As the tabletop top labeler can switch products without changing parts or using tools, workers will not have to spend much time on the changeover process.

The desktop labeler can apply labels to flat surfaces of various products such as paper boxes, foil bags, zipper bags, plastic boxes, boxes even books.

Tabletop Automatic Top Labeler is suitable for

Flat-surfaced products such as files, folders, tags, cards, boxes, tins,



envelopes, packages, trays, bags, books, etc.

Label

Self-adhesive labels, anti-counterfeit labels, promotional labels, tamper-evident labels, tube labels, vial labels, lab labels, transparent labels (work with photoelectric sensor for transparent labels).

Labeling style

labeling on a flat surface, labeling on the front and back, and labeling on the side.



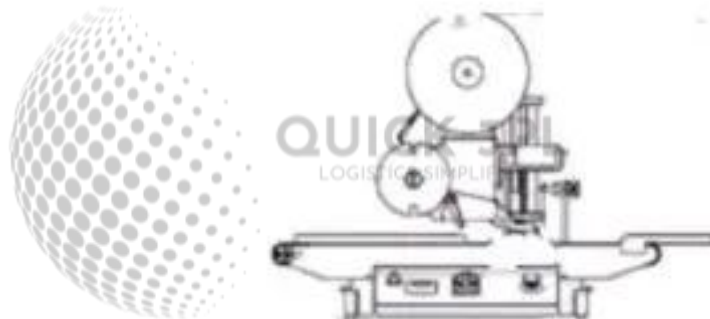
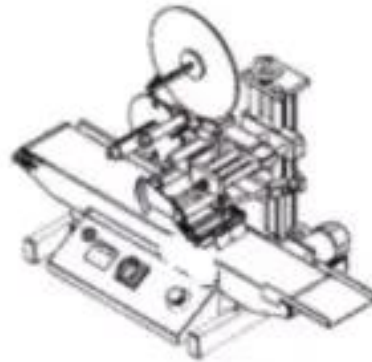

Features

1. Tabletop Automatic Top Labeler is equipped with highly accurate photo-electronic eyes, which detect targeted labeling positions with great precision.
2. Equipped with industrial-level abrasion-resistant conveyor belts, providing high clamping power and durability.
3. Tabletop Automatic Top Labeler is powered by stepper motors, and it fulfills labeling tasks with great accuracy and efficiency.
4. Modularized machine parts; all parts are processed with engineering methods that enhance their structural solidity.
5. Synchronized CPU and PLC control system; visualizing labeling outputs.
6. Programmed with a PLC control system, simplifying the operation process.
7. Tabletop Automatic Top Labeler is made of SUS #304 high-quality



- stainless steel and hardened aluminum alloy, providing easy maintenance and cleanup.
8. Comes with automatic label counters that monitor your labeling outputs with ease.
 9. Small in size but great in production efficiency.
 10. Setting up label length through the PLC system, making changes to applications fast and easy.
 11. Built-in computer programs and a humanized interface free you from complicated manual parameter settings, minimizing training duration.
 12. Photo-electronic eyes automatically detect targeted labeling positions, freeing you from the troubles of manual adjustments when changing labels and applications.
 13. Adjustable labeling heads make it easy to fine-tune labeling angles and heights, optimizing productive efficiency.
 14. User-friendly designed hand wheel system, adjusting label heads fast and easily.

Specification

- **Labeling Speed:** 20-80 pcs/min (subject to actual label size)
- **Labeling Precision:** ±1 mm
- **Applicable Label Width/Length:** 10-100mm/10-250mm
- **Label Reel Diameter:** Inside 75mm; Outside 300 mm
- **Power Input:** 110/220 VAC; 50/60 Hz
- **Dimensions:** (L) 1200mm (W) 520mm (H) 780mm

Option Accessories

- Photoelectric eye for transparent labels.
- Powerless top hold-down belt (suitable for applications that are light and thin).
- Date coding machine

Categories: [Tabletop Labeller](#), [Tabletop Labelling Machine](#)



TABLETOP TOP LABELER

SKU: LT1100

Our LT1100, tabletop top labeler, works with high efficiency while providing perfect labeling results at the same time. The tabletop top labeling machine comes with a brush and sponge roller to smooth labels, which helps to achieve an excellent labeling result.

Our Tabletop Top Labeler is compact in size, easy to move, and best suited for small batch production. You can easily set parameters through the microcomputer control interface without complicated procedures. Moreover, the user-friendly interface allows our clients to become familiar with the operation easily. The highest labeling speed is up to 3600 pcs/hour.

Widely used in various industries and products

Our Tabletop Top Labeler is not only suitable for general products you may see at the store, but packaging from various industries, such as precooked meals, bakery boxes, medicine boxes, facial masks, and cosmetics products. There's a growing need for using food delivery platforms to order meals during the pandemic.

More disposable packages have been used, such as paper cups, lunch boxes, cake boxes, zipper bags, and plastic bags. The flat surface label applicator LT1100 is the best choice to apply labels onto your product cost-effectively.

Unlike round bottle labelers, the LT1100 flat label applicator attaches stickers on the top, side, or bottom of the product. And it's not limited to flat containers, for example, the top of caps, the bottom of plastic cups, boxed snacks, and gift boxes which are common products in our daily life, are all applicable.



High production efficiency and economic benefits improve customer market competitiveness



Manual labeling is difficult to achieve accuracy and fast production. You can easily avoid human errors and improve production efficiency by using our label applicator for flat surfaces.

Our Tabletop Top Labeler LT1100 has no complicated setting procedures, so it's easy to operate. This labeler is equipped with high-precision sensors, giving you high productivity with accurate labeling results, thereby strengthening your capacity and market competitiveness.



We provide customers with valuable labeling solutions and maximize the interests of our clients from our many years' experience. Our labelling equipment and bottle filling packaging machines are people-oriented, which emphasize versatility, flexibility, convenience, simple operation, and cost reduction.

We believe that we can satisfy all customer requirements through integrated solutions and outstanding production lines.

Advantages:

- The Tabletop Top Labeler is convenient to move around and space-saving.
- Tabletop Top Labeler can be operated by a non-professional with easy procedures. Operators can adjust the label applicator position with a lever. The label length is set directly with touch-tone design buttons.
- The sticker applicator machine is shipped with sensors from well-known brands. It provides fast, accurate, and high-quality labeling.
- The Tabletop Top Labeler can smooth stickers with brushes or a sponge roller to make labeling results more refined.
- LT1100 Tabletop Top Labeler desktop label applicator can be combined with our other machines to build an automatic production line.



e.g., card feeder, bag feeder, date coder, and transparent label sensor.

- High efficiency enhances the production capacity and market competitiveness for customers.

Application & Advantage

Suitable goods

Cosmetics, Facial mask, Almond chocolate, Candy box, Dried fruit, Cereal, Family size potato chips, Tea bag, Drip coffee, Coffee bean, Food delivery box, Paper cup, Frozen food, Animal feed, Cake box, Dish soap, Laundry ball, Soda power, Wet wipe Duster sweep sheet, Poster paint, Hard card, Memory card, Card, Album, Envelope, Automotive parts, Screen protector, Notebook, Kraft paper, Zipper bag, Spout bag, Aluminum foil bag, polypropylene (PP) plastic bag.



Suitable container shape

Most are suitable for flat products with top labeling, which usually paste labels on the top, side, or bottom of containers.

Suitable container material: Paper, Glass, Aluminum foil, Zipper bag, Plastic (PP, PE, PET), Metal (tinplate, aluminum can).



Labeling style



QUICK 3PL

LOGISTICS SIMPLIFIED

Attach the stickers on the top of the product while the product passes through the label applicator. Next, the peel plates and brushes will make sure the final product is intact with no wrinkles or bubbles.



Suitable industries

Machinery manufacturing, Cosmetic industry, Food processing/manufacturing industry, Bakery industry, Pharmaceutical industry, Catering industry, Electronic product industry, etc.

Machine Layout

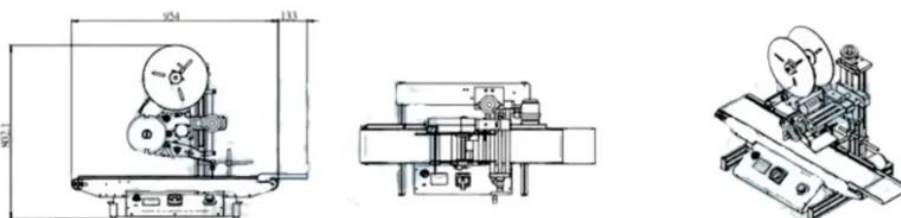

Features

1. High-quality labeling: The sticker applicator machine is equipped with a Japanese sensor, which makes labeling fast and precise. Production with top labeling, use smooth label components to ensure the finished products are beautiful without wrinkles.
2. The operation method is simple: A user-friendly interface, like hand wheel adjustment and touch-tone design, can not only



eliminate the complicated setting procedure, but also avoid the loss caused by human error. The company can reduce education and training for its employees as well.

3. The label applicator, whose height and angle can be adjusted, it's driven by an automatic stepper motor. The labeling process is stable and precise.
4. Wide-ranging of labeling products, suitable for different self-adhesive labels in various industries. Labeling is not limited to flat products, but is also applied to the top, side, or bottom of three-dimensional products.
5. The desktop label applicator machine saves time and space. One table can start production because it's small in size with high mobility.
6. The conveyor belt is made of PVC, which has a high coefficient of friction. It's smooth and durable. The conveyor belt can be adjusted its speed flexibly based on customer requirements.
7. LT1100 tabletop top labeler can be combined with our card feeder, bag feeder, and date coder as a production line to save labor costs.
8. Tabletop Top Labeler is made of SUS#304 stainless steel and aluminum alloy. The tabletop top labeler is firm and durable; besides, it's easy to maintain.

Specifications

- **Labeling Speed:** 30–60 pcs/min (depending on label size)
- **Label Size:** Length 10–300 mm; Width 10–100 mm
- **Label Roll:** Inner Diameter 75 mm; Outer Diameter 300 mm
- **Machine Size:** (L) 950 mm × (W) 580 mm × (H) 730 mm
- **Accuracy:** ±1 mm
- **Power Supply:** 110/220 VAC; 50/60 Hz

Option Accessories

- Card feeder
- Bag feeder
- Laser coder
- Date coder
- Transparent label sensor

Categories: [Tabletop Labeller](#), [Tabletop Labelling Machine](#)



QUICK 3PL

LOGISTICS SIMPLIFIED



QUICK 3PL

LOGISTICS SIMPLIFIED



TABLETOP TWO-SIDED LABELER (WITH TWO LABEL APPLICATOR)

SKU: LT1252



Tabletop two-sided labeler LT1252 is designed specifically to fulfill labeling tasks with high precision and efficiency. It is the first small-sized two-sided labeler with two labeling heads on the market. Its labeling heads can be synchronized to provide service. Such a feature enables the tabletop two-sided labeler LT1252 to apply two labels, of different sizes, to two different targeted positions in one single process.

Unlike traditional labelers that require you to repeatedly feed products to apply labels on both sides, all that a two-sided labeler needs is to put the labeling products on its conveyor belts. This way, the tabletop two-sided labeling machine not only greatly improves your productivity but also significantly saves your labor costs.

The Tabletop Two-Sided Labeler That Offers High Labeling Precision ($\pm 1\text{MM}$)

LT1252 is powered by stepper motors and thus provides steady labeling outputs. It shares the same controlling system as standard top labelers and standard flat-surface labelers, that is, a built-in micro-computer program. Such a controlling system has a user-friendly interface, which helps to free you from complicated manual parameter settings. Tabletop Two-Sided Labeler's labeling speed is 20-40 pcs/ min, depending on the specificity of your products.

LT1252 is a two-sided labeling machine that applies up to two labels in a single process. Its two labeling heads can operate either independently or coordinately, depending on your production needs. Its labeling precision reaches $\pm 1\text{mm}$, which is the best choice for businesses with high precision needs. Tabletop Two-Sided Labeler comes in a space-efficient size and thus is the top choice for businesses with limited workplace space. It also works for an extensive range of applications, including electronics with high-precision labeling needs, SSD labeling, serial number labeling, paper boxes, plastic boxes, documents, anti-counterfeiting stickers, cosmetics, disposable contact lens boxes, and labels of pharmaceutical drugs etc.

The rear part of the tabletop two-sided labeler can be drilled to leave preparatory holes for supporting poles in case of future production needs or in case of future installation of other packaging equipment to build up a production line.

Features

1. Equipped with two labeling heads, which can provide services with



- only one head or with two heads, either independently or coordinately.
- Both labeling heads are powered by stepper motors, allowing labeling at two different targeted positions, decreasing feeding time, and optimizing productivity.
 - Optional Japanese-made stepper motors or servo motors according to production needs.
 - Streamlined conveyor unit is space-efficient, minimizing space restrictions.
 - Smart labeling system, easy to operate, minimizing complicated manual parameter settings.
 - Controlled by micro-computer programs; Its user-friendly interface minimizes learning duration.
 - Adjustable labeling speed suits various labeling needs.
 - High labeling precision ($\pm 1\text{MM}$) makes the two-sided labeler the best labeling solution for the IT and electronics industry.
 - Programmed with a counter, visualizing productivity with clarity.
 - Each labeling head has its hand wheel, adjusting labeling angles and heights fast and easily.
 - A micro-computer-based program makes it easy to set up for one-sided or two-sided labeling.
 - Equipped with two independent photo-electronic eyes, each detects the targeted labeling position and labeling products independently.
 - Adjustable labeling speed: either in automatic mode or in manual mode.
 - Incorporating two labeling heads in tabletop labelers: a significant breakthrough on the market.
 - Automatically detect the length of labels through program settings.
 - Made of stainless steel and aluminum alloy, it comes with solidity and durability.

Specification

- **Labeling Speed:** 20-40 pcs/min
- **Labeling Precision:** $\pm 1\text{MM}$
- **Applicable Label Width/Length:** 10-100 mm/ 10-300 mm
- **Label Roll Diameter:** Inside 75 mm/ Outside 300 mm
- **Power Input:** 110/220 VAC

Option Accessories

- Photoelectronic eye for transparent labels
- Date coding machine
- Material receiver/feeder



QUICK 3PL
LOGISTICS SIMPLIFIED

- Servo motor units

Categories: [Tabletop Labeller](#), [Tabletop Labelling Machine](#)



QUICK 3PL
LOGISTICS SIMPLIFIED

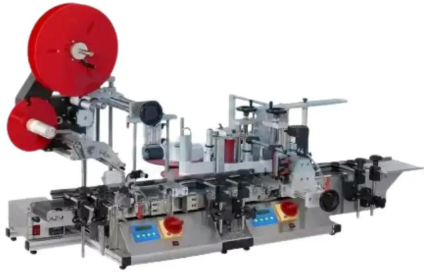

TABLETOP WRAP AROUND AND TOP LABELER

SKU: LR1300 / LT1100

Tabletop Wrap Around and Top Labeler equipped with a round bottle labeling head and a top labeling head, **wrap wrap-around and top labeling LR1300 and LT1100 tabletop labeler** fulfills labeling tasks of round bottles and top label through a single process. Tabletop Wrap Around and Top Labeler's greatest advantage is its capacity to carry out the two labeling tasks within one single process.

Its fixed-point round bottle labeler can either apply wrap-around or semicircle labels on single or two sides of round bottles with high accuracy and within a minimal error range. The labeling speed of the Tabletop Wrap Around and Top Labeler is 20 - 50 pieces/min, depending on your specific products or label sizes.

One Labeling Machine, Two Ways Of Labeling

The tabletop wrap-around and top labeler is powered by stepper motors with fixed-speed drives. Its conveyor belt is synchronized with its two labeling heads, which can either work independently or coordinately, through which the tabletop wrap-around and top labeling machine can fulfill the tasks of round bottle labeling and flat labeling in one single process.

Tabletop Wrap Around and Top Labeler applies to round bottles made of all kinds of materials and those with top labeling. Its applications include body lotion bottles, essence bottles, wine bottles, perfume bottles, nail polish bottles, ice cream buckets, lipstick cases, nutrition supplement bottles, chicken extract bottles, detergent bottles, and shampoo bottles, etc.

Tabletop Wrap Around and Top Labeler applies standard labels, promotional labels, and anti-counterfeit labels (an optional photoelectronic eye for transparent labels is available). It works with products of a wide range of industries such as cosmetics, pharmaceuticals, IT, food, and the chemical industry.

Therefore, the tabletop wrap-around and top labeler NLR-130 + NLT-100 is the best solution for businesses with only limited workplace space but with versatile labeling needs.

Features

1. Both round bottle labelers and top labelers are equipped with high-quality Japanese-made photo-electronic eyes that automatically detect applications and operate according to



- settings.
2. Pneumatic fixed-point round labeling unit fulfills labeling tasks with great precision.
 3. Powered by fixed-speed stepper motors, providing steady labeling outputs.
 4. This multi-functional labeling machine is of great space efficiency, providing an outstanding bottling solution for businesses with limited workplaces.
 5. Built-in parameter settings in the micro-computer program free you from complicated manual parameter settings, minimizing learning duration.
 6. The "One machine, two ways of labeling" feature satisfies an extensive range of labeling needs.
 7. Fixed-point round bottle labeler applies wrap-around and semicircle labels with high precision.
 8. Tabletop Wrap Around and Top Labeler's synchronized conveyor belts and labeling heads move products with stability and apply labels with precision.
 9. The two labeling heads can work independently or coordinately, boosting the productivity of versatile labeling.
 10. The right-angle labeler contains a unique folding mechanism, which is able to press the label on the cap and on the bottle body at the same time, and firmly applies labels on targeted positions.
 11. Provided with hand wheel adjustment tools, adjusting labeling angles and heights with ease.
 12. When applying different labels, the machine will automatically detect the length of the new labels through its photo-electronic eye, minimizing manual parameter settings.
 13. An optional material receiver plate and date imprinting machine could be added to optimize productivity.
 14. Tabletop Wrap Around and Top Labeler is made of SUS#304 stainless steel and high-quality aluminum alloy; it is solid and durable.

Specification

- **Powered by stepper motors**
- **Labeling Speed:** 20-50 pcs/min (depending on your specific products and label sizes)
- **Applicable bottle size:** Diameter 16mm-100mm; Height 30mm-160mm
- **Applicable Label Width/Length:** 10 mm - 100 mm / 10 mm - 300 mm
- **Label Roll:** Inside 75mm; Outside 300mm
- **Power Input:** 110/220 VAC, 50/60 Hz
- **Dimensions:** (L) 1620mm (W) 950 mm (H) 810 mm

Option Accessories

- Photoelectronic eye for transparent labels
- Automatic bottle feeding machine/receiving machine
- Date coding machine



QUICK 3PL
LOGISTICS SIMPLIFIED

Categories: [Tabletop Labeller](#), [Tabletop Labelling Machine](#)



QUICK 3PL
LOGISTICS SIMPLIFIED



SEMI-AUTOMATIC ROUND BOTTLE LABELLER

SKU: LR1100



The Semi-automatic Round Bottle Labeller is used for labeling all sizes of round bottles and upright cylindrical products. The label is wrapped around the bottle with a full circle, a 2/3 circle, and a half circle.

It can also apply labels on the front and back of the round bottle. Various kinds of containers can be labeled by this labeling machine, such as PE bottles, PET bottles, PP bottles, other plastic bottles, glass bottles, metal bottles, etc. Semi-automatic Round Bottle Labeller can perfectly apply the label to the product and helps manufacturers to improve the quality of packaging.

And Semi-automatic Round Bottle Labeller is controlled by knobs and a microcomputer system, which makes it easier for the operator to use and learn quickly.

High Productivity With Low Manpower

The purpose of the tabletop round bottle labeler is to automatically apply labels to various round bottles and cylindrical products. Its labeling applicator is driven by an advanced stepper motor for stable and precise labeling operation.

This tabletop labeling machine offers the same advantages and accuracy as the automatic stand-type bottle labeling machine, providing you with high productivity and reducing labor requirements.

With the Semi-automatic Round Bottle Labeller's compact design and small size, it does not occupy too much production space and is widely used in various industries, including food and beverage, cosmetics, health food, pharmaceutical products, cleaning products, chemical products, etc.

LR1100 Equipped With Liftable Wrapping Unit To Provide Higher Labeling Position For Special Bottles

The LR1100 tabletop bottle labeler features a wrapping unit equipped with a height adjuster, which allows the label to be attached to higher parts of the bottle, providing a wider labeling position.

Semi-automatic Round Bottle Labeller's simple design and eye-catching red label spool disc make it easy for users to identify the label quantity. And it is easy and fast to change the label roll. Its automatic sensor system detects the product and controls the dispensing of the label, and the wrapping unit makes the label firmly adhere to the product, enhancing the quality and aesthetics of the labeled product.





With the simple adjustable mechanism, the Semi-automatic Round Bottle Labeller is versatile and can be used on a wide range of round bottles. It is the most economical labeling solution for small and medium packaging production.



Wide Application, One Labeler, Both For Large And Small Bottles

In addition, the advanced round bottle labeler can be equipped with more adjustment units according to your special needs. The labeling height and angle can be adjusted according to the product size to accommodate more types of round bottles, oval bottles, and other round containers to achieve more diverse labeling methods and improve the applicability of the labeler. One labeler can apply to several products in various sizes and styles. More options will be proposed according to your actual needs.





Advantages:

- Economic labeling machine, suitable for you to pursue high labeling quality
- Flexible connection to various packaging machines for filling/counting-capping-labeling compact production line
- No need for a lot of manpower, one person can operate the labeling machine individually

Application & Advantage

Suitable for

Edible oil bottles, sauce bottles, wine bottles, medicine bottles, beverage bottles, beer bottles, tea tins, skin care products, lotion, essential oil bottles, wine products, shampoo, detergent, perfume, health food, etc., and all kinds of upright cylindrical products.

Applicable Container Style

Round bottles and cylindrical products, products that can stand upright and that require wrapping around or a half circle.

Applicable Container Materials

Glass bottles, cans, aluminum cans, and other metal containers can be labeled. Paper products, PE bottles, and PET bottles.



Applicable Label

Self-adhesive labels (non-transparent), promotional labels, bar code labels, security seal labels, anti-counterfeit labels, tamper-proof labels, anti-tampering labels, tamper-proof labels, film labels, sealing labels, laser labels, computer labels, fragile labels, laser anti-counterfeit labels, or transparent labels (need to use the transparent label sensor).



Labeling Style

Label wrap around the container with a full circle, 3/4 circle, 2/3 circle, 1/2 circle, or a single label on front and back.

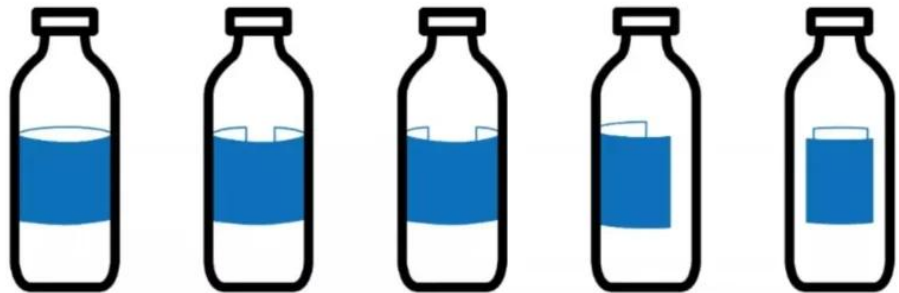

Applicable Industries

Pharmaceutical industry, food industry, biotechnology industry, beauty manufacturing industry, chemical industry, high precision product technology industry, etc.

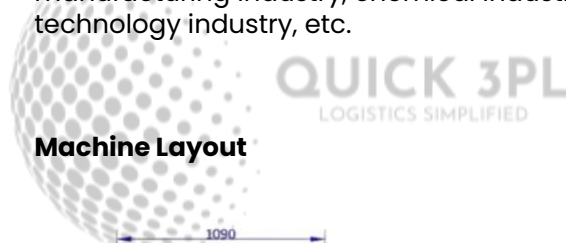

Machine Layout

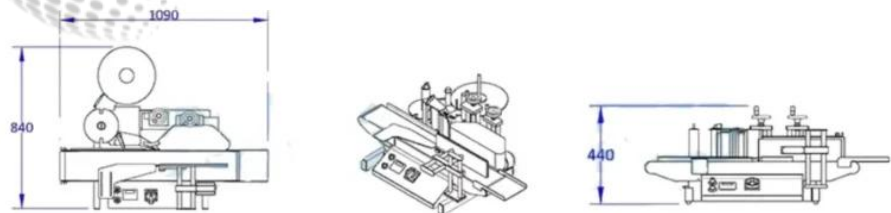

Features

1. Microcomputer-controlled, easy operation, and high precision of the round bottle labeling machine.
2. The control knob is integrated into the control box for easy and smooth operation.
3. The labeling applicator is driven by a stepping motor for precise positioning and stable production speed, which makes it easy to control the production capacity.
4. Semi-Automatic Round Bottle Labeller is equipped with precision photoelectric sensors to accurately detect labels and products for precise labeling positions.



5. Semi-Automatic Round Bottle Labeller is controlled by a microcomputer processor to set parameters according to product labeling requirements.
6. An advanced labeling applicator is available as an option. More adjustment units are available to adjust the labeling height and angle according to the product size, which is suitable for manufacturers with a wide variety of products.
7. Motor-driven conveyor and wrapping unit can be speed-adjusted to meet capacity requirements.
8. Small in size and requiring only one table for production space, which is suitable for small and medium production labeling needs.
9. The tabletop labeling machine can be used directly as a stand-alone machine or connected with a filling machine and a capping machine to build a compact production line according to the actual production.
10. The label dispensing length can be set by a button.
11. Semi-Automatic Round Bottle Labeller's main frame is constructed of stainless steel and hardened aluminum alloy, which is strong and cGMP compliant.
12. When changing the labeled product, the label can be replaced quickly without disassembling any parts, easily and time-saving.
13. Adjust the wrapping unit according to the size of the product and the height of the label position to make the label attach more smoothly.
14. Semi-automatic Round Bottle Labeller is equipped with an output counting function, easy to monitor the output number.
15. Tabletop Round bottle labeler with simple user interface, versatility, and low maintenance cost
16. The label is smoothed with a sponge wrapping unit to maintain the integrity of the container and not damage the bottle during labeling.
17. The modular structure of the labeler is designed with good quality, precision, and high efficiency.

Specification

- **Label applicator motor:** stepping motor
- **Labeling speed:** 10m/min
- **Capability:** 20~40pcs/min (subject to actual label size and product)
- **Labeling accuracy:** +/- 1mm
- **Bottle size:** (Dia)16mm-100mm; (H)30-160mm
- **Label size:** (L) 10~310 mm; (W) 10~100 mm
- **Label roll:** (ID) 75mm ; (OD) 300mm
- **Power Supply:** 110v or 220 VAC; 50/60Hz; single phase
- **Dimension:** (L) 1010mm (W)845mm (H)445mm
- ***The actual dimension may vary depending on configuration; detailed specifications are subject to the actual order.**

Option Accessories



- Transparent label sensor
- Date coder
- Printer Bracket
- Customized guide rail
- Customized conveyor

Photo Gallery





Categories: [Tabletop Labelling Machine](#), [Tabletop Labeller](#)





TABLETOP HORIZONTAL ROUND BOTTLE LABELER

SKU: LR1600

The Tabletop Horizontal Round Bottle Labeler is designed to be used in a small production space. There are different kinds of bottles, like slender bottles, small diameter bottles, and long bottles that can't stand well. The Tabletop Horizontal Round Bottle Labeler can provide a more accurate labeling method.

With positioning labeling, stickers are not easy to deviate. Also, when changing product stickers, it is easy to adjust and no need to replace parts. The operator doesn't spend much time to learn this machine. Tabletop horizontal round bottle labeler can share different kinds of size round containers' stickers.

Tabletop Horizontal Round Bottle Labeler is suitable for various slender round cylinder stickers, and the product won't be limited by material, such as lipstick, test tube, pencil, syringe, ampoule bottle, vial, battery, filter, and small round bottle, etc.

No matter is half-wraparound, full wrap-around, or partially overlapping, all can be applicable for the products. It can be applied to industries such as pharmaceutical, food, cosmetics, biotech, technical, technology, and chemical.

The Smallest Dimension Tabletop Horizontal Round Bottle Labeler With High Accuracy, Which Is Used To Label Mini Slender Round Bottles.

In respect that the current market has only produced an automatic horizontal round labeler, we are devoted to developing a small, spaceless one for those who specialize in small capacity production lines. Such a space-efficient feature makes it the best solution for enterprises having only a limited workplace.

Tabletop Horizontal Round Bottle Labeler has higher accuracy that could label those bottles that need to be kept flatwise. Besides, you could combine optional equipment as you want to promote productivity, such as a feeder, a collecting rotary table, and a date coding machine.

We also have an automatic labeling machine that is suitable for higher production, for example, automatic horizontal round bottle labelers LR3600, LR4600, and multiple types of labeling machines.

Specifications:

Features



1. Small-sized horizontal round bottle labeler comes in a small size, is space-saving, and can operate on the table.
2. It is easy to operate, just press the button then it can start operating.
3. Highly steady labeling, labels, and products can match smoothly.
4. Different kinds of label setting parameters add flexibility to machine applications.
5. Exclusive positioning device for the bottle, improving labeling accuracy.
6. The small diameter round bottle could be labeled for one complete circle through contact rollers that are continuously rolling.
7. Tabletop Horizontal Round Bottle Labeler has adjustable labeling speed and can be fitted depending on your production.
8. Control buttons can be integrated into the control box together and are easy to adjust.
9. It is suitable for non-transparent, anti-forgery barcode labels.
10. Additional construction: date coding machine and collecting rotary table, which can improve production.
11. Tabletop Horizontal Round Bottle Labeler is easy to maintain, and you don't need to disassemble the machine. Light and time-saving.
12. Tabletop Horizontal Round Bottle Labeler made of SUS#304 stainless steel and aluminum alloy for frame construction. More durable and solid.

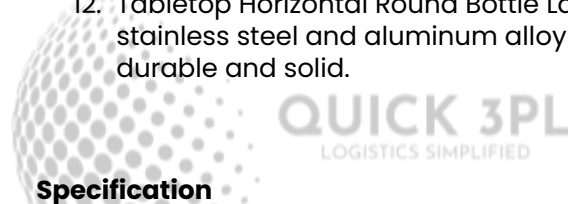

Specification

- **Labeling speed:** 4 meters/min
- **Labeling accuracy:** +/- 0.5mm
- **Label size:** (Min.) W 10mm x L 10mm (Max.) W 100mm x L 300mm Labeling speed: 4 meters/min
- **Labeling accuracy:** +/- 0.5mm
- **Label size:** (Min.) W 10mm x L 10mm (Max.) W 100mm x L 300mm
- **Label reel:** inner diameter 75mm / Outer Diameter 300mm
- **Tube diameter:** 10-90mm
- **Power:** 110 or 220VAC, 50/60Hz, 1P
- **Air pressure requirement:** 2.5 kg/cm²
- **Dimension:** (L) 675mm x (W) 490mm x (H) 575mm
- **Motor:** stepper motor

Option Accessories

- Automatic feeder
- Collecting rotary table
- Date coding machine
- Air compressor

Categories: [Tabletop Labeller](#), [Tabletop Labelling Machine](#)



QUICK 3PL

LOGISTICS SIMPLIFIED



QUICK 3PL

LOGISTICS SIMPLIFIED



TABLETOP VERTICAL ROUND BOTTLE WRAP AROUND LABELING MACHINE

SKU: LRI300

The Tabletop Vertical Round Bottle Wrap Around Labeling Machine is the only tabletop spindle round bottle labeler on the market. We developed the first small spindle round bottle labeling machine on the market to meet different round bottle labeling production needs.

Tabletop Vertical Round Bottle Wrap Around Labeling Machine is perfect for enterprises venturing into automated production. Its small size, versatility, and economical pricing make it a top choice for small- to mid-size manufacturers, compared to bulky, expensive industrial-size machinery.

Labeling speed ranges from 15 ~ 30 pieces per minute, with a precision of $\pm 0.5 \sim 1$ mm (depending on product size and shape). It's a great tool for increasing productivity.

The LRI300 Tabletop Vertical Round Bottle Wrap Around Labeling Machine is used for full-circumference labeling on cylindrical products, such as condiments, beverages, alcohol, soap, cosmetics, medications, detergents, and more. Though most bottles may seem perfectly cylindrical, there are often bumps and ridges on the surface, which can affect labeling precision (not true cylinders).

This type of bottle tends to cause wrinkled or skewed labeling, but not with the vertical round bottle wrap-around labeler, which uses rollers to keep bottles in place during labeling and can handle longer labels easily, such as three-quarter or full circle labeling.

One Tabletop Vertical Round Bottle Wrap Around Labeling Machine For Multiple Products; The Best Tool For Labeling Precision

We place the utmost importance on user friendliness over complicated settings. Anyone can learn how to use and maintain the machine, and the parameters are easily set. The Tabletop Vertical Round Bottle Wrap Around Labeling Machine automatically recalls the last set of parameters each time it is turned on, reducing downtime between production batches.

The labeling position can be adjusted using the handwheels, which include a parameter screen for labeling consistency.

The Tabletop Vertical Round Bottle Wrap Around Labeling Machine is made of SUS#304 stainless steel and high-quality aluminum, and the electronic parts are Japanese-made, meeting cGMP medical-grade standards.



The biotech, food and beverage, cosmetic, chemical, and packaging industries can all benefit from using the Tabletop Vertical Round Bottle Wrap Around Labeling Machine, which can be used alone or in a production line with other machines.

Some optional machines include infeed/outfeed turntables, automatic or semiautomatic cappers, fillers, tablet counters, and more for even higher production efficiency.

Advantages

1. Only tabletop vertical round bottle wrap-around labeling machine on the market
2. Tabletop design, suitable for small spaces
3. Low-quantity, high-variability design makes it perfect for small companies
4. Suitable for 3/4 circle or full circle label
5. Different labels and bottles can be used with this machine
6. Can provide complete bottling production line planning

Application & Advantage

Suitable for:

Plastic bottles, glass bottles, cans, aluminum cans, metal cans, jars.

Suitable labels

Self-adhesive stickers, anti-counterfeit labels, promotional labels, tamper-evident labels, barcode labels.

Labeling style

Wrap-around, half, three-fourths, or full circle.



QUICK 3PL
LOGISTICS SIMPLIFIED



Features

1. Pneumatic bottle positioning device for accurate labeling
2. Can be used for most self-adhesive stickers, anti-counterfeit labels, promotional labels, tamper-evident labels, and barcode labels
3. Labels 10-15 pcs/min, with $\pm 0.5\sim 1$ mm precision
4. Tabletop design for limited space and high mobility
5. Labeling height and angle are adjustable
6. The most economical model can be connected with a production line or used alone
7. Uses high-quality conveyor belt for stable labeling with a low-noise motor
8. Simple control box for user friendliness
9. All controls are on the control box for easy operation
10. All sorts of parameters, increasing production flexibility
11. Tabletop Vertical Round Bottle Wrap Around Labeling Machine can be used as soon as it is turned on, saving parameter setting time
12. Advanced KEYENCE sensor for automatic label size detection
13. Tabletop Vertical Round Bottle Wrap Around Labeling Machine has a high-quality Japanese-made stepper motor for high efficiency and accuracy
14. Made of SUS#304 stainless steel and aluminum alloy for frame



- construction to comply with cGMP standards
- 15. Can add coders to print dates and batch numbers
- 16. No need for disassembly when doing maintenance
- 17. Can add a customized labeling head
- 18. Can add infeed and outfeed turntables
- 19. Can add capping machines, filling machines, or tablet counting machines

Specification

- **Speed:** 15~30 BPM
- **Accuracy:** $\pm 0.5\sim 1$ mm
- **Bottle Size:** Diameter: 16~100mm; Height: 30~160mm
- **Label Size:** Width:10~100mm; Length:10~300mm
- **Label Reel:** Inner Diameter: 75mm; Outer Diameter: 300mm
- **Power Supply:** 110 or 220VAC, 50/60Hz, single phase
- **Machine Size:** (L)1265mm (W)990mm (H)525mm
- ***Actual product specifications may vary**

Option Accessories

- Date coder
- Customized labeling head
- Customized rollers
- Capping machine
- Filling machine
- Tablet counting machine
- Infeed turntable
- Outfeed turntable

Categories: [Tabletop Labeller](#), [Tabletop Labelling Machine](#)



QUICK 3PL

LOGISTICS SIMPLIFIED



QUICK 3PL

LOGISTICS SIMPLIFIED



INDEX

A

Automatic Card Feeding Machine 19

F

Friction Feeder 21

L

Label Applicator 1

Label Dispenser 16

Label Dispenser With Date Printer 13

S

Semi-automatic Round Bottle Labeller 55

T

Tabletop Automatic Top Labeler 39

Tabletop Bottle Labeling Machine (Standard Model) 22

Tabletop fully wrap around labeler 27

Tabletop Horizontal Round Bottle Labeler 62

Tabletop Round Bottle Labeling Machine 35

Tabletop Tamp Labeler 31

Tabletop Top Labeler 43

Tabletop Two-Sided Labeler (with two label applicator) 49

Tabletop Vertical Round Bottle Wrap Around Labeling Machine 65

Tabletop Wrap Around and Top Labeler 52

Top Label Applicator 7

Top Tamp Labeler (Top Tamp Labeling Machine) 33